

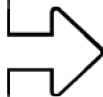

# Friends™

41704

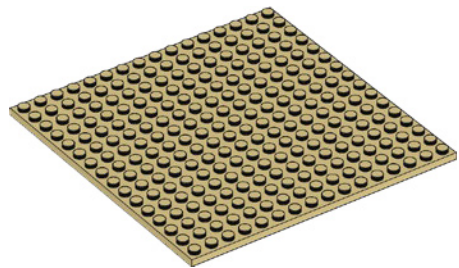



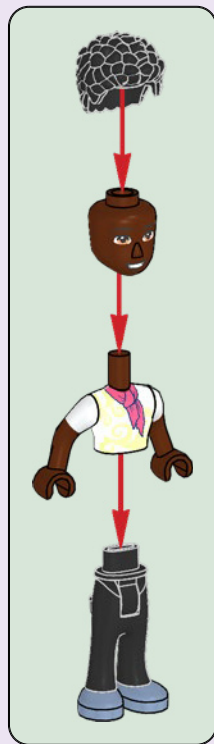

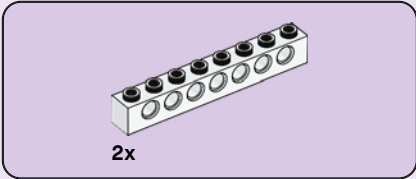

1

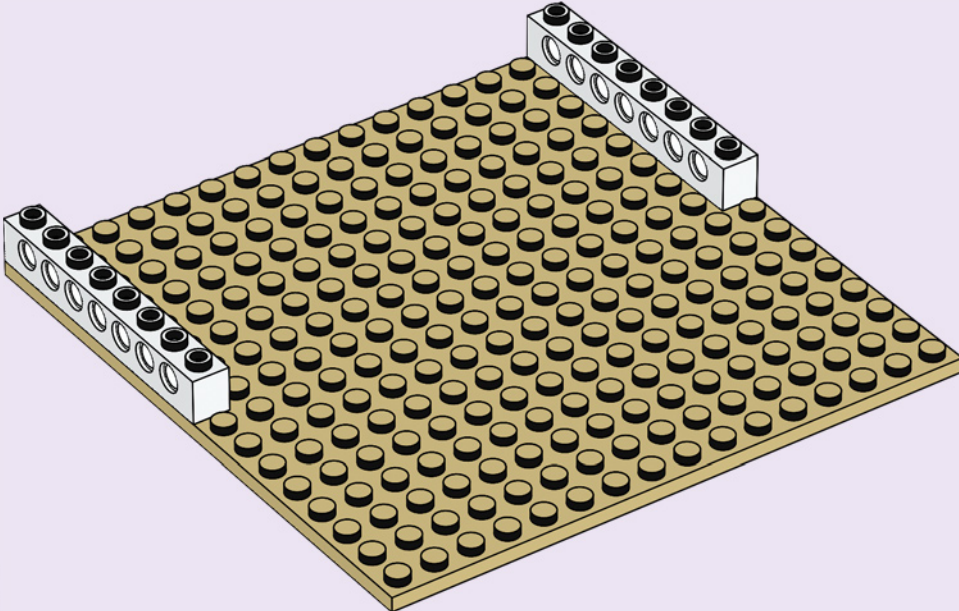

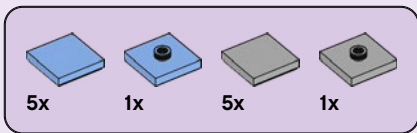

2

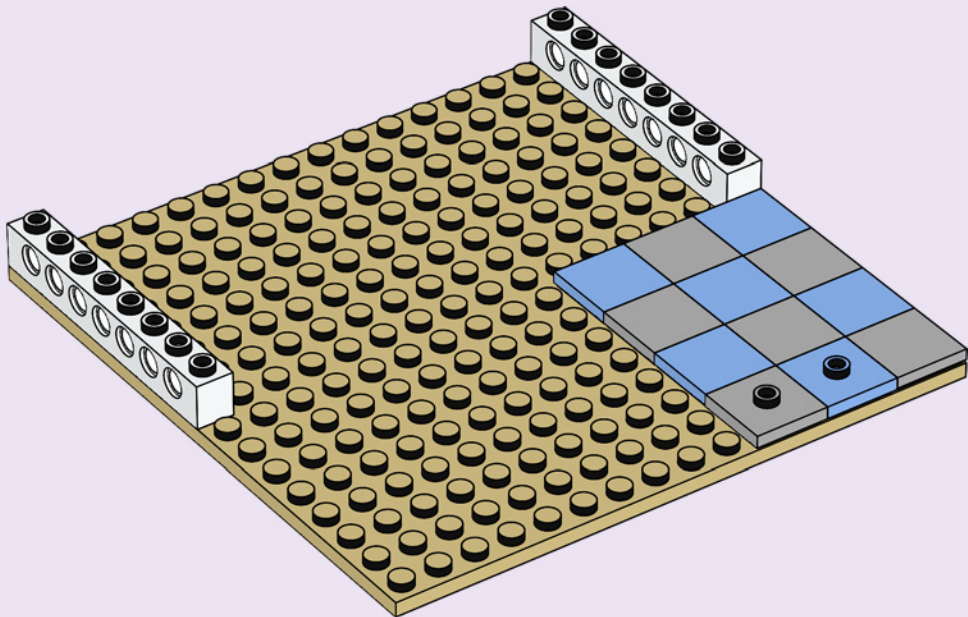

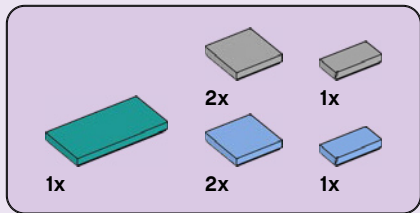

3

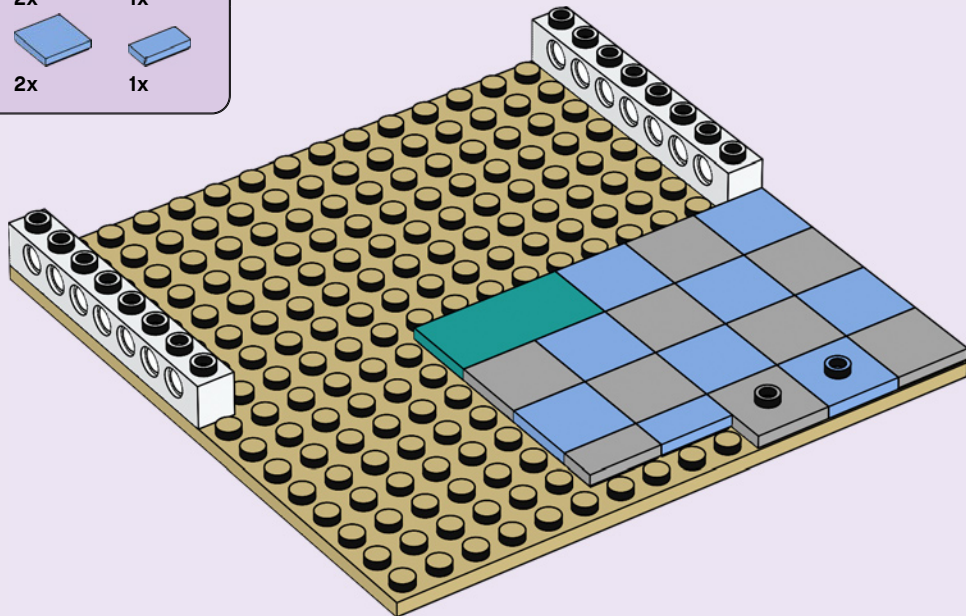



2x



1x

4

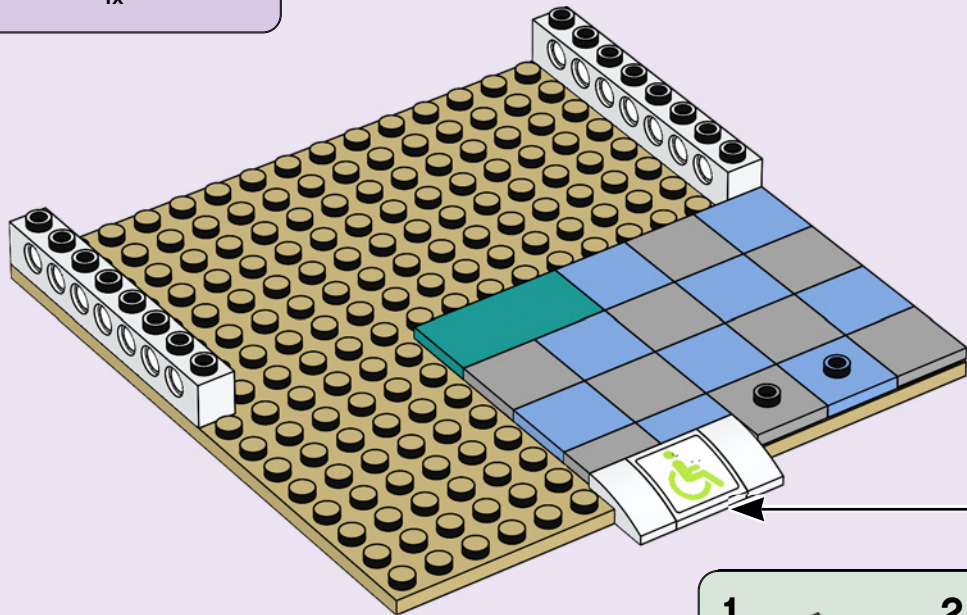

1



2



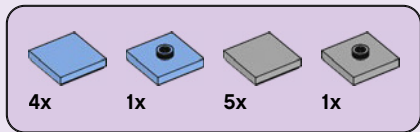

5

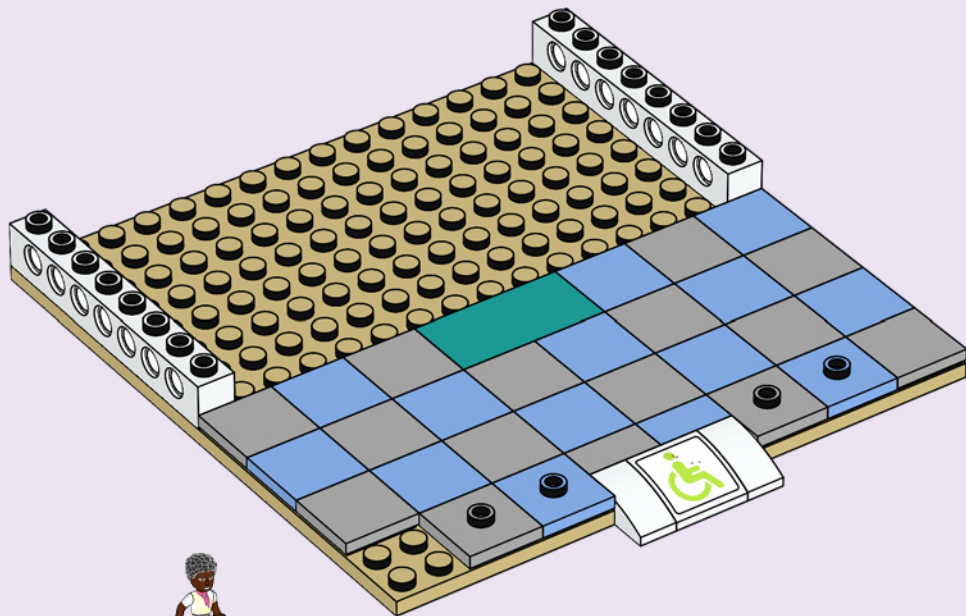



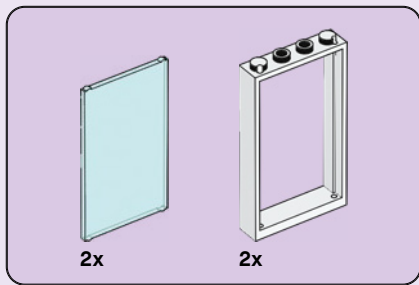

6

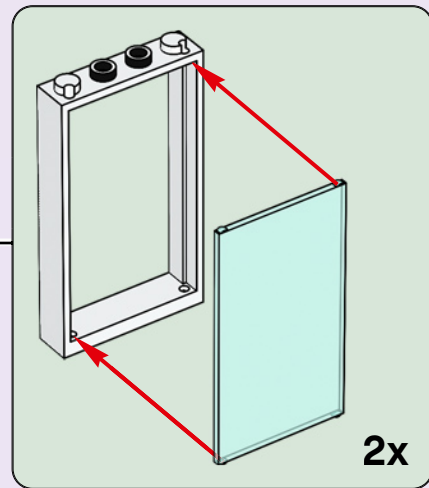
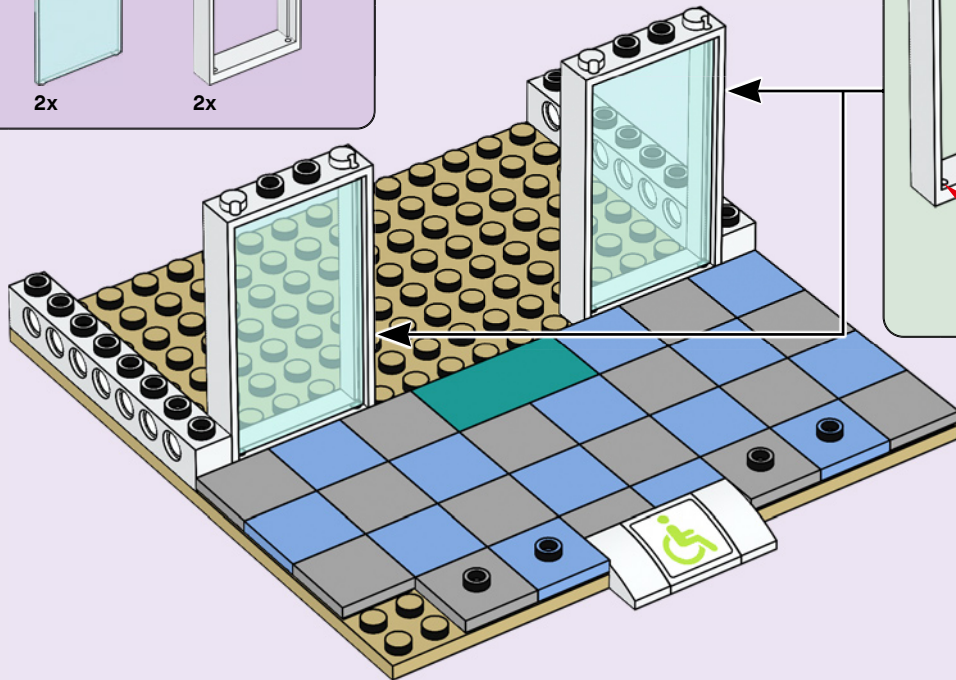

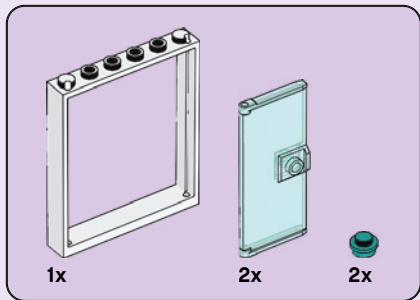

7

1

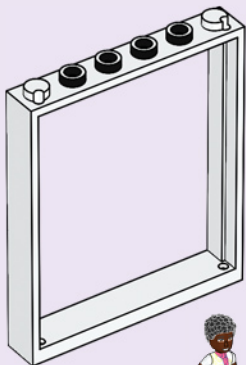

2

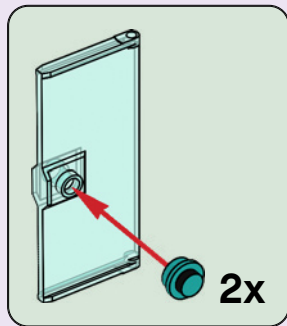
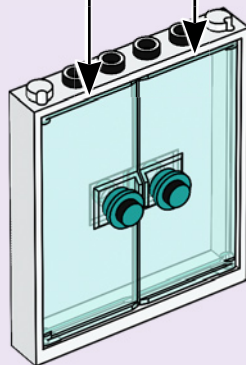

2x



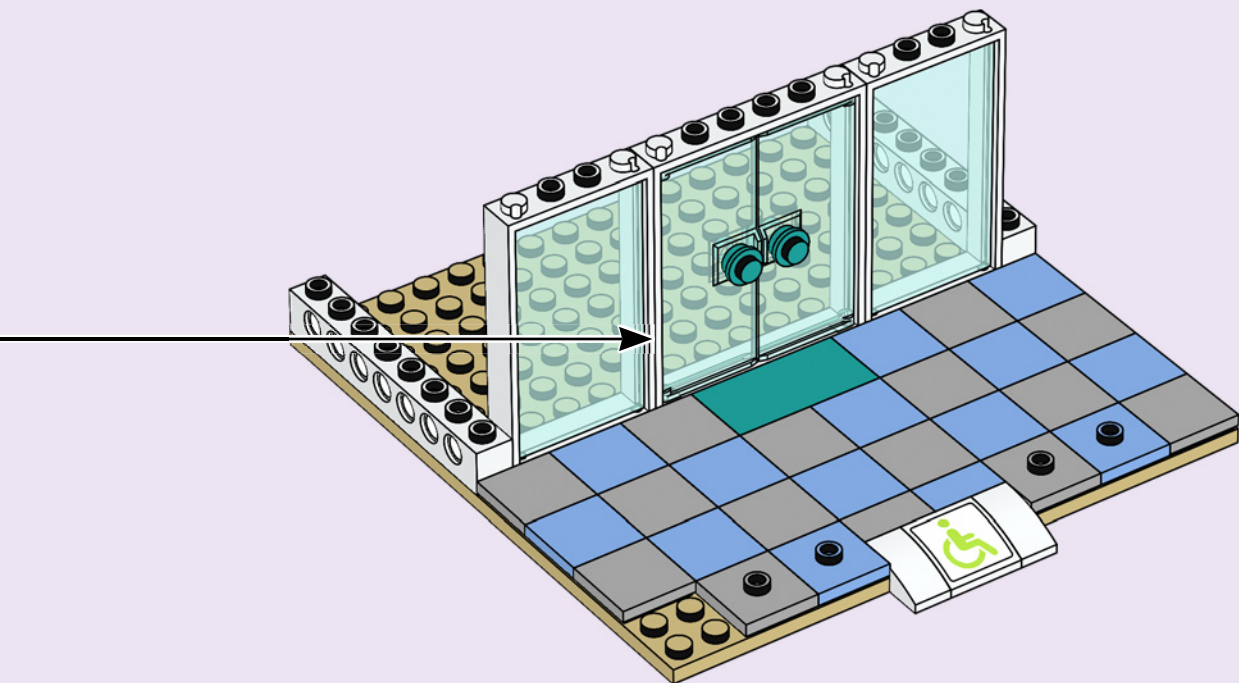

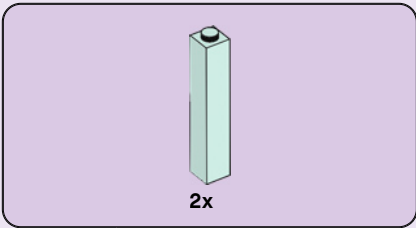

8

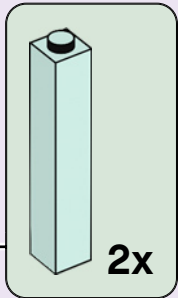
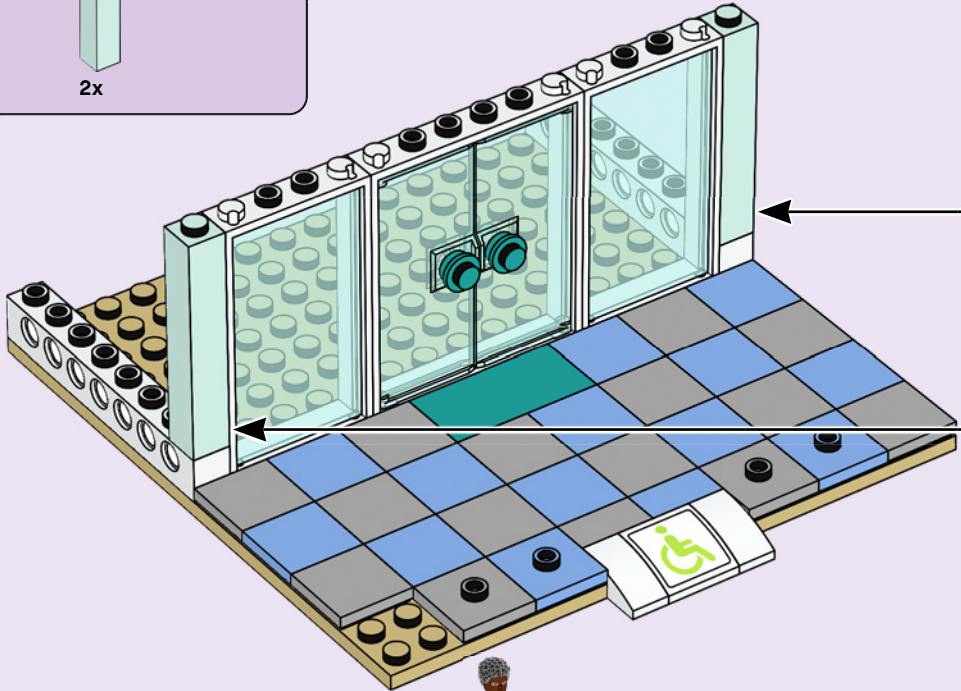



2x



1x

9

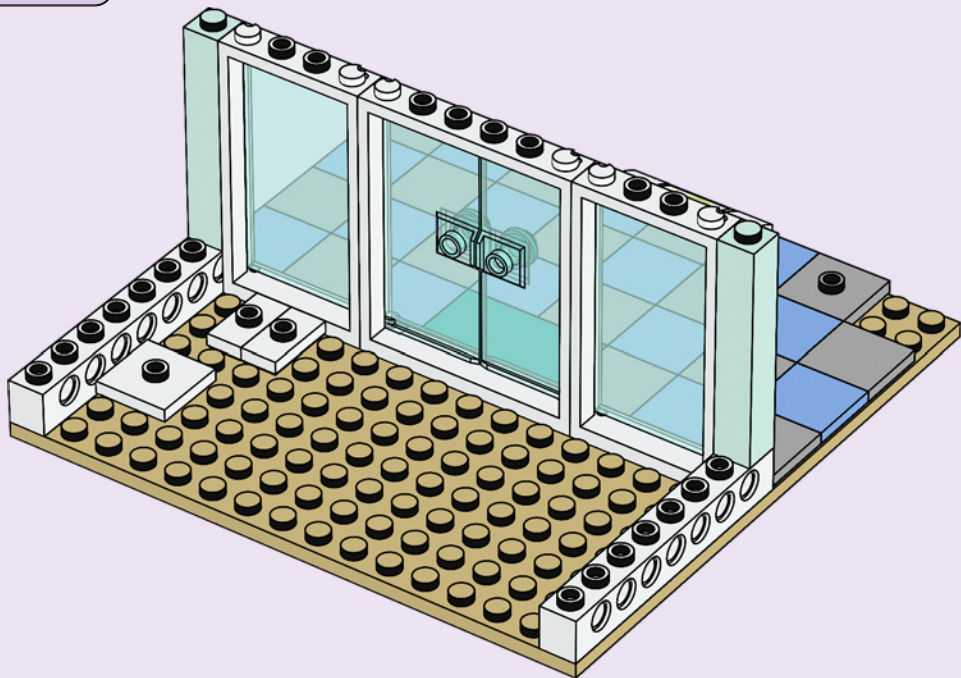

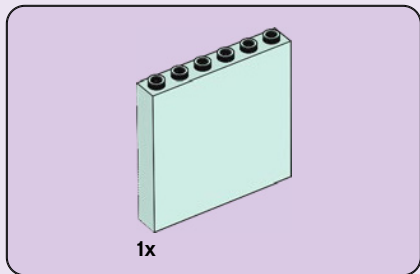

10

1

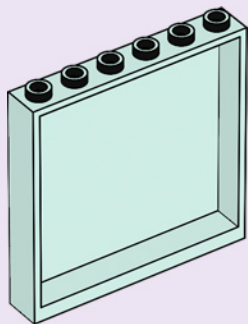

2



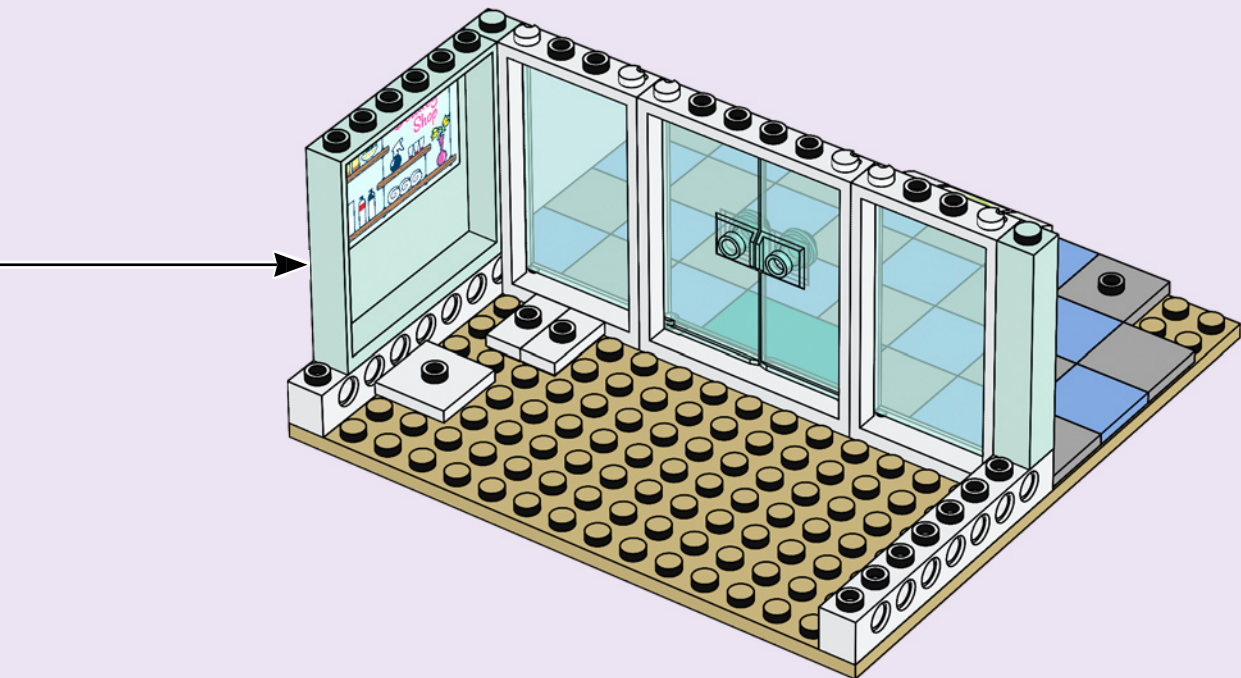

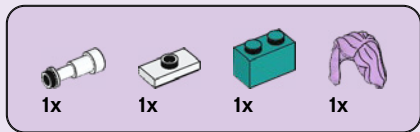

11

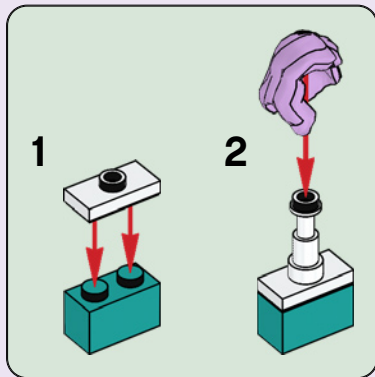





1x



1x



1x

# 12

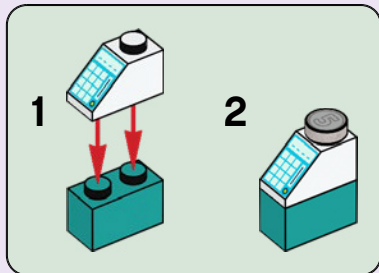

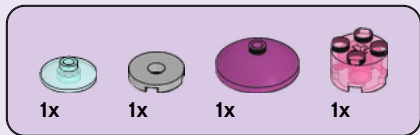

13

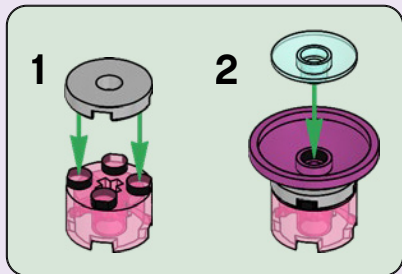



1x

14



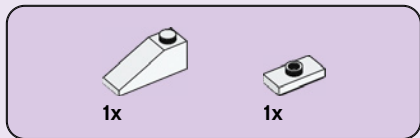

15



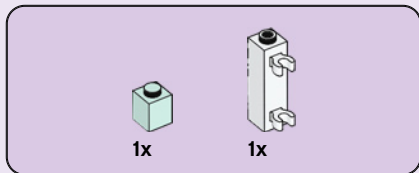

16



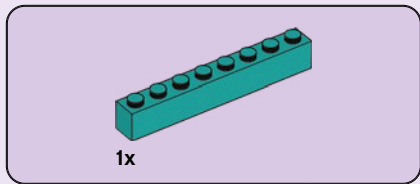

17



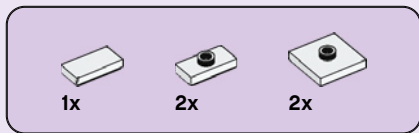

18

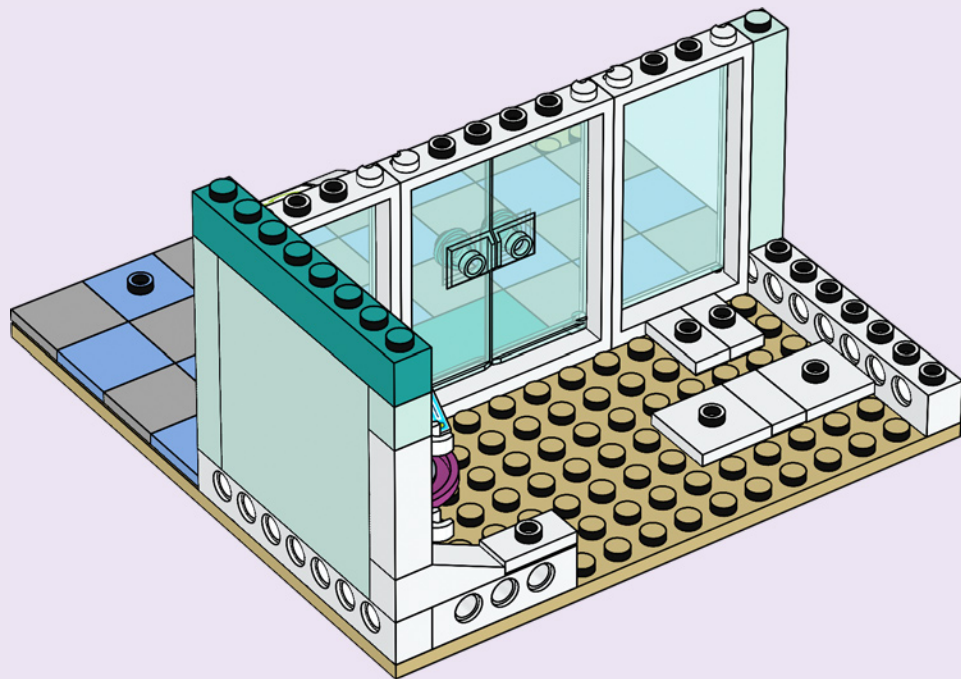

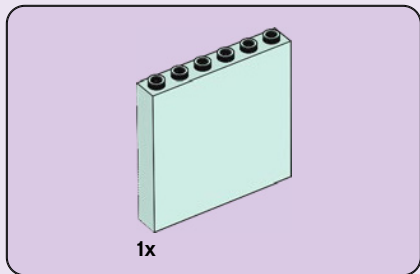

19

1

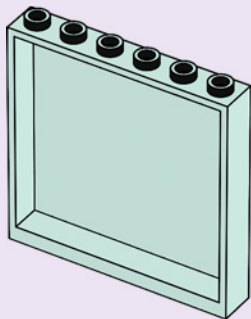

2

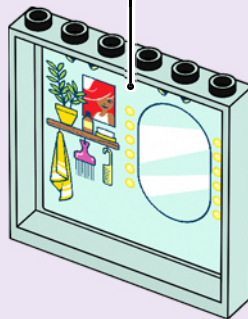



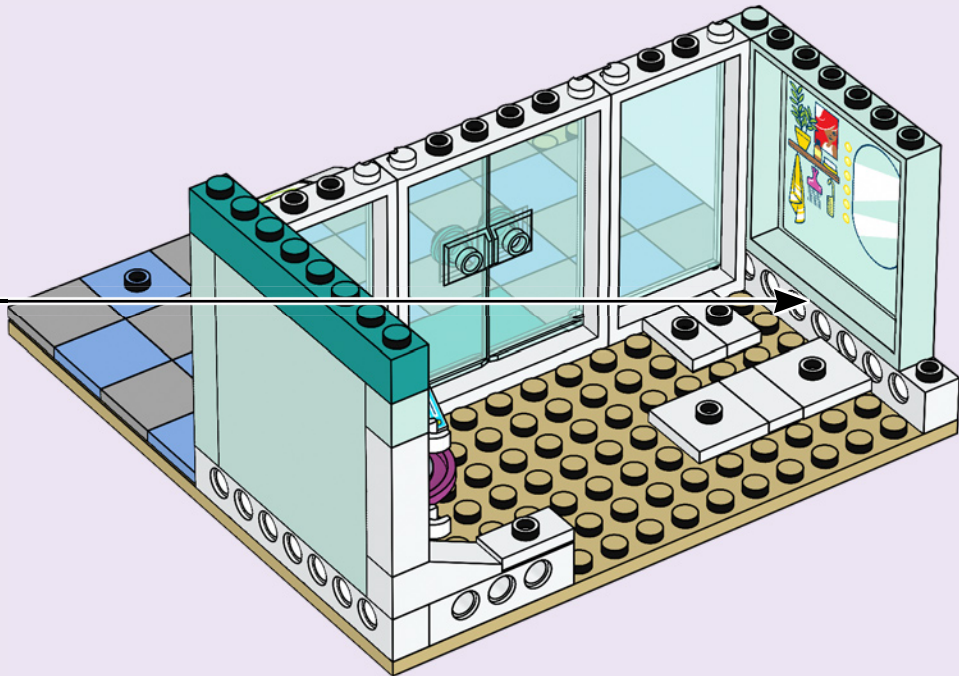



2x



1x

20

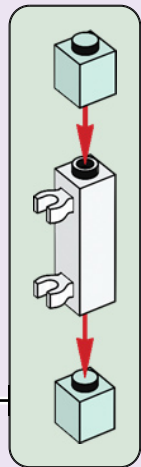
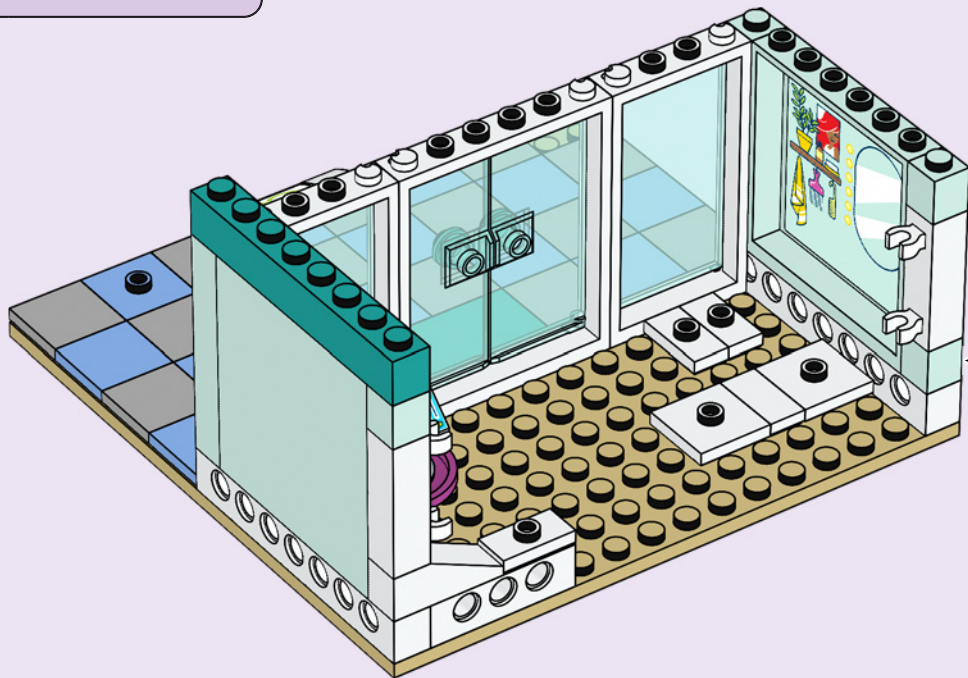

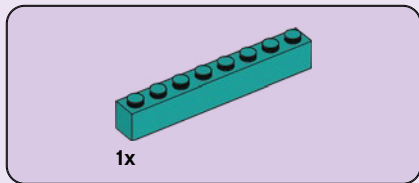

21

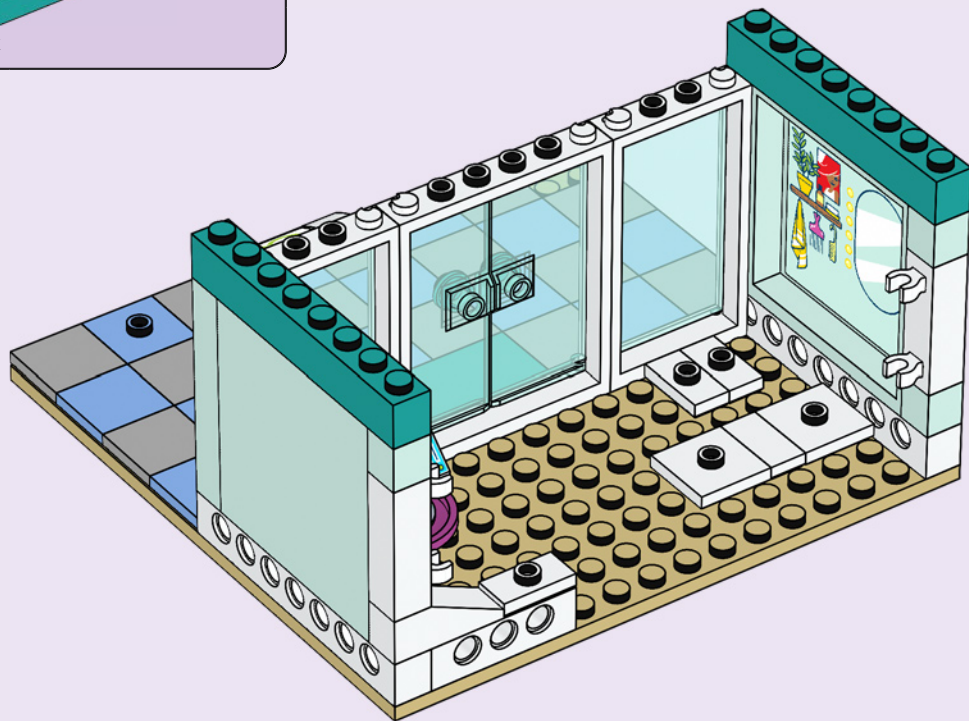

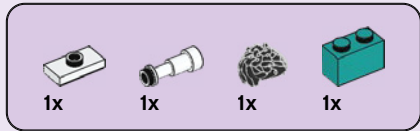

22

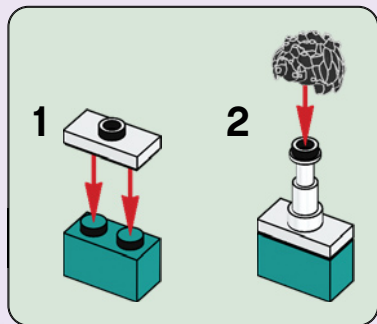
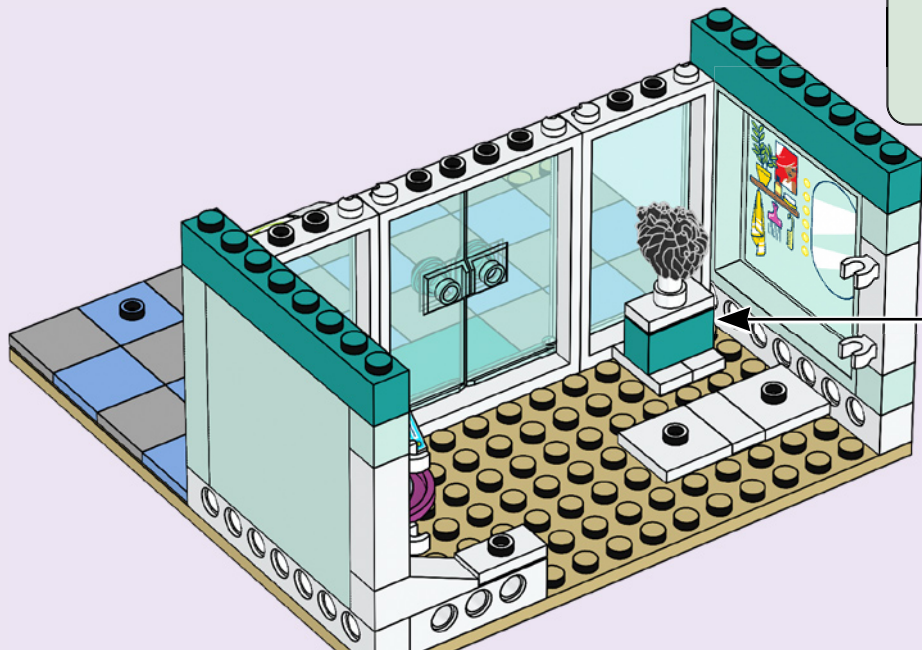

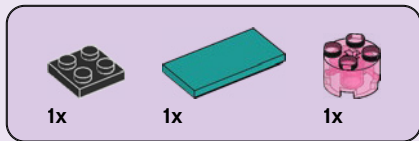

23

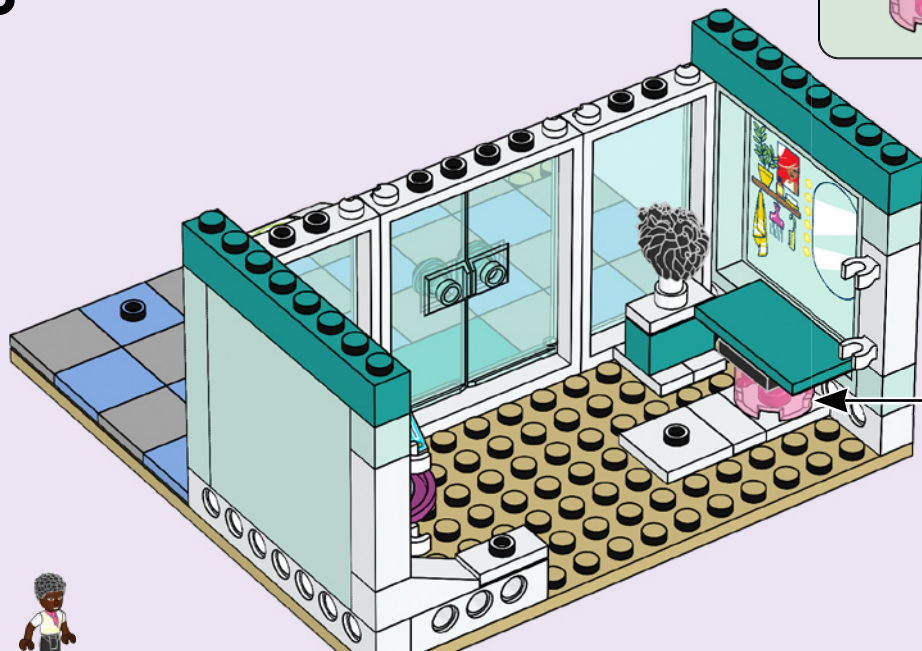
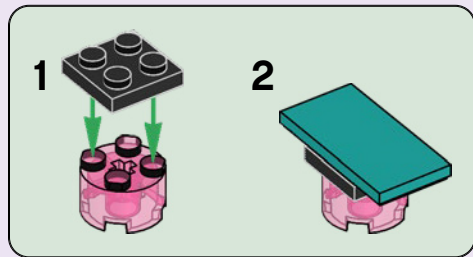

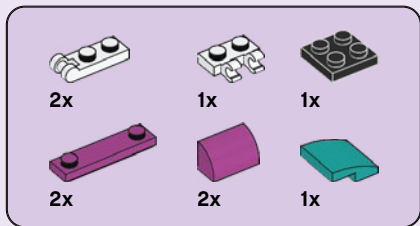

24

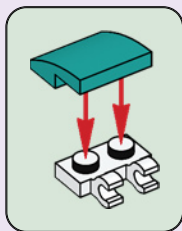

1

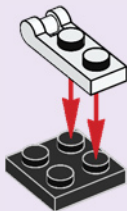

2



3



4

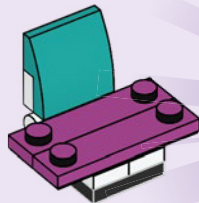

5



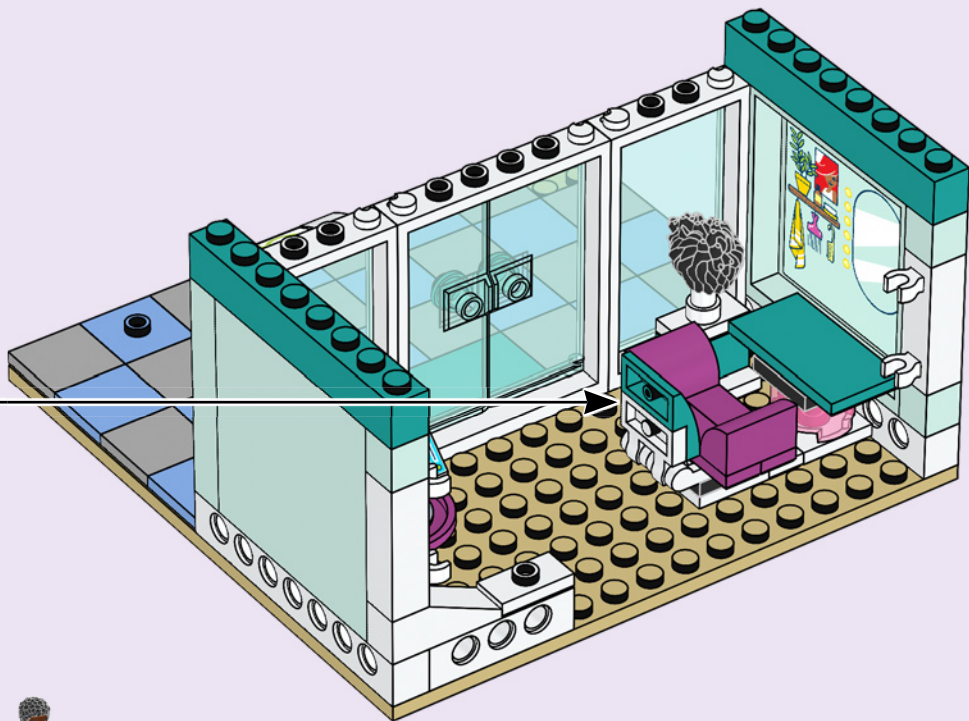

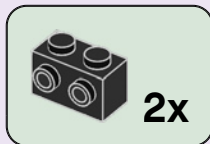
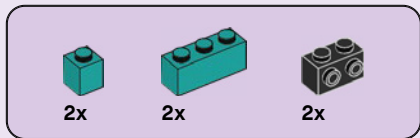

25

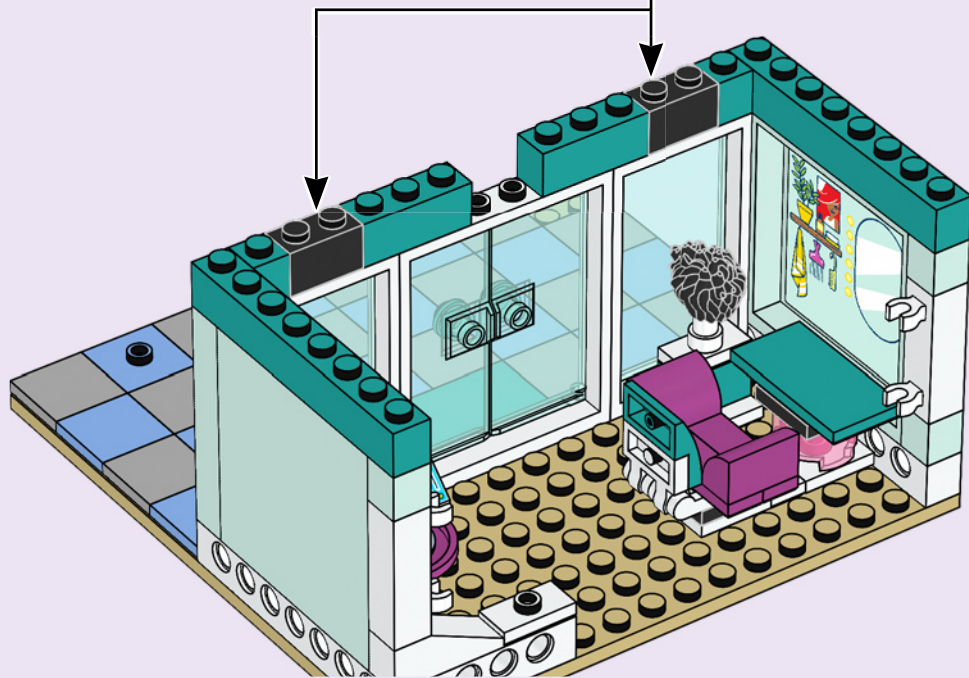



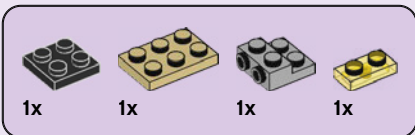

# 26

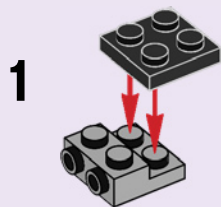

2

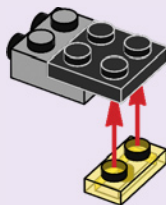

3

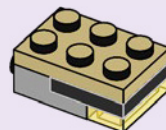

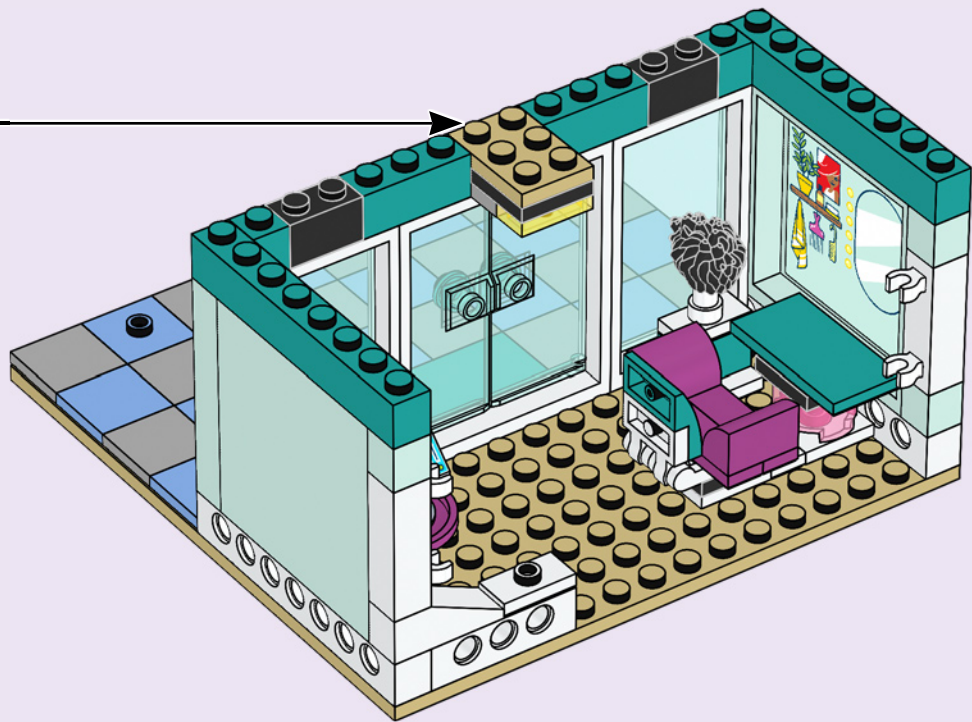

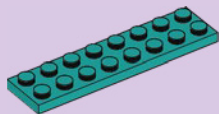

2x

27



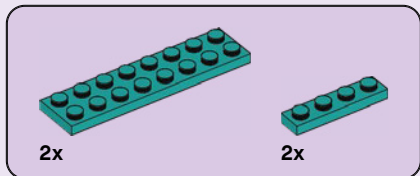

28

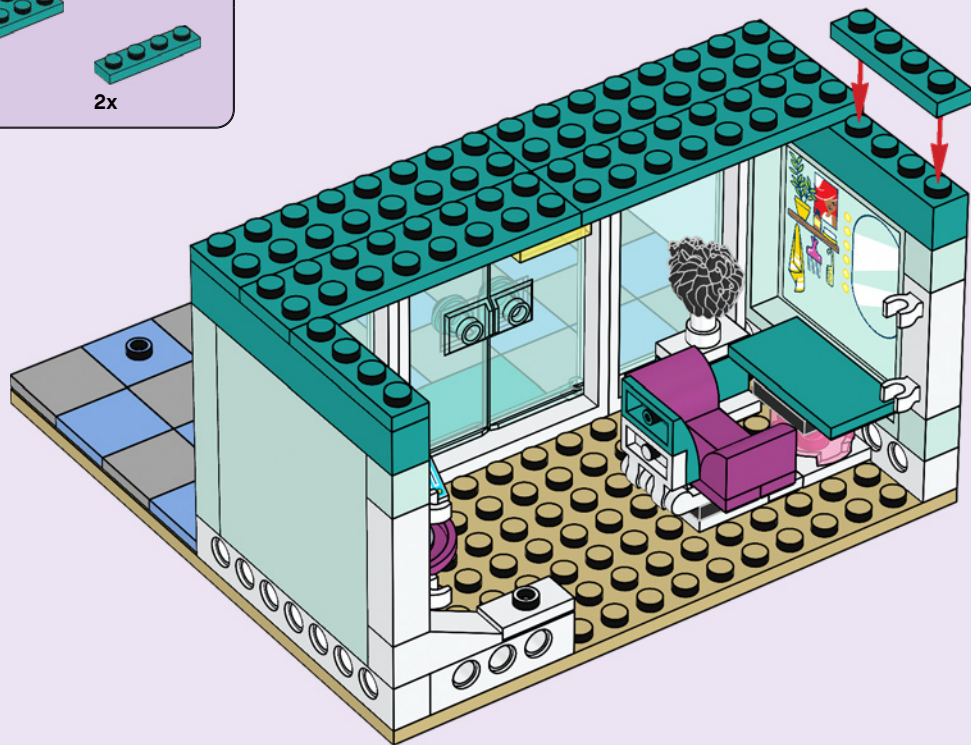

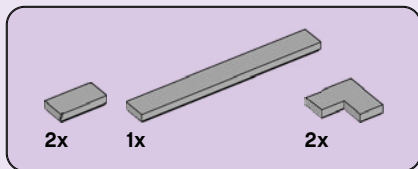

29

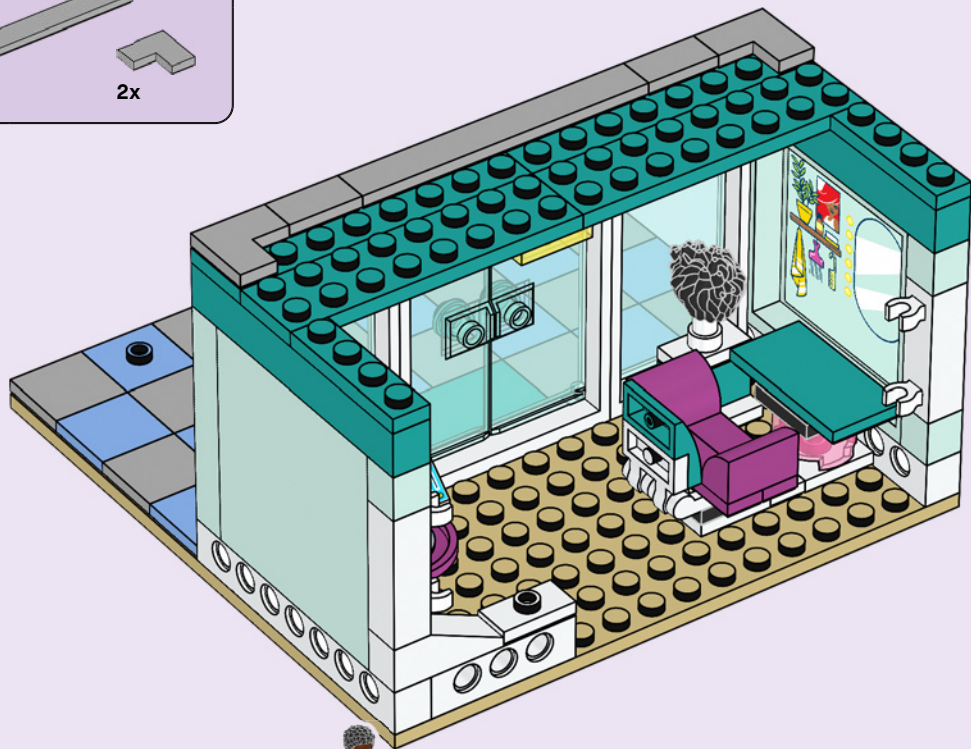

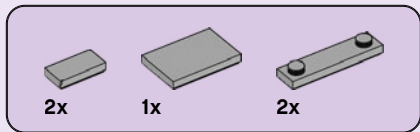

30

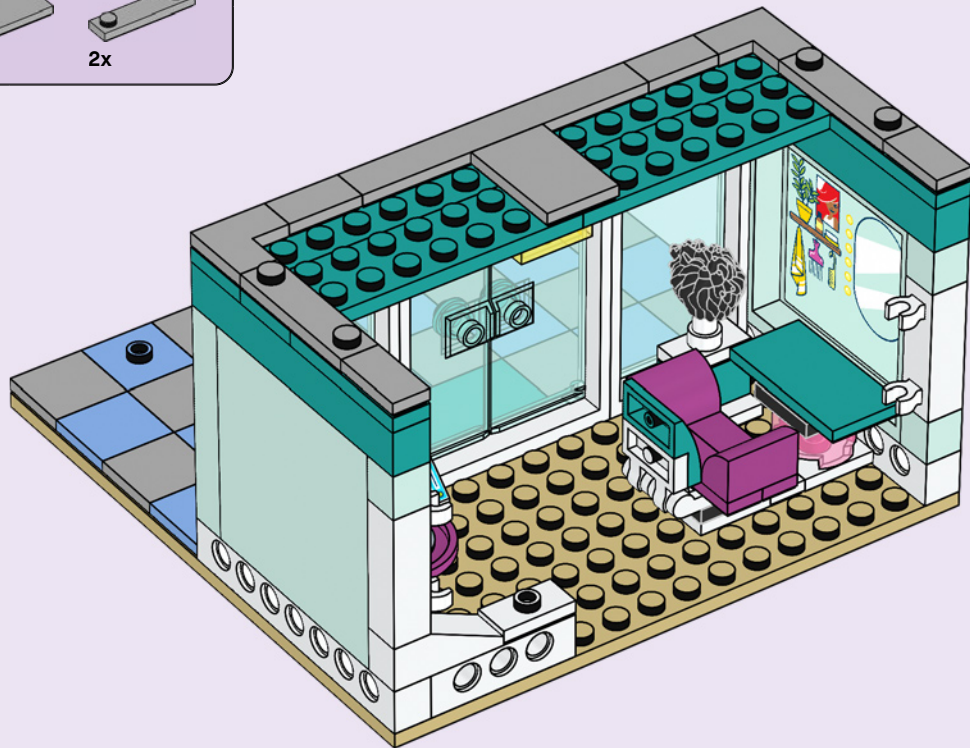



31

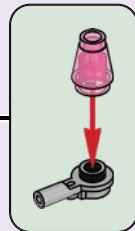
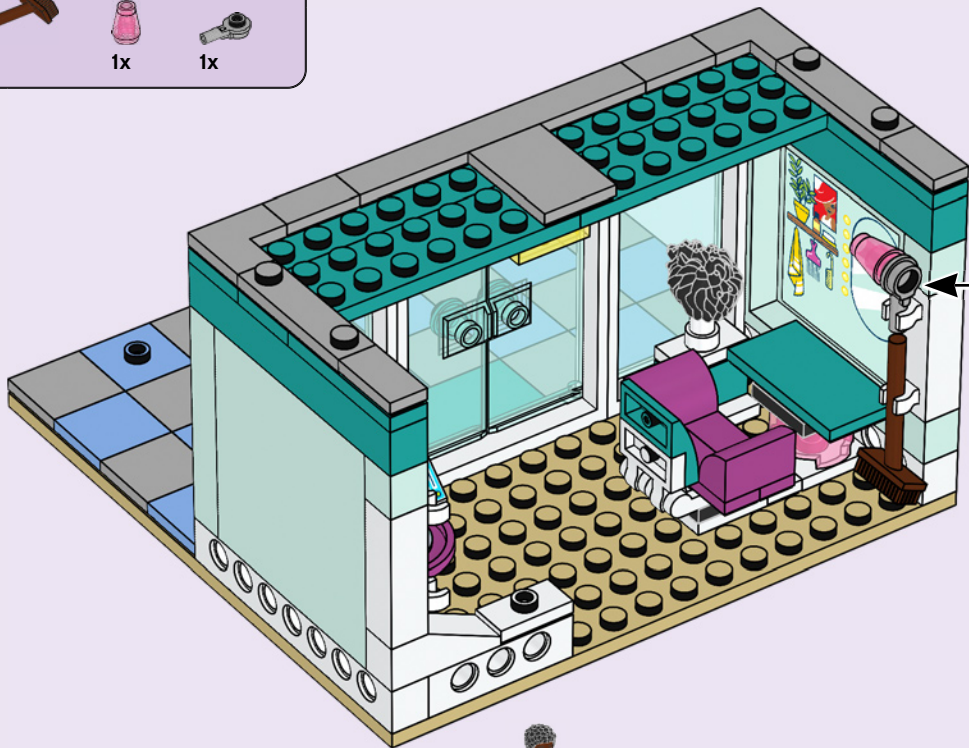



1x



1x



1x



1x

# 32

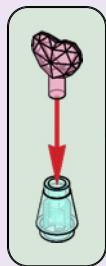



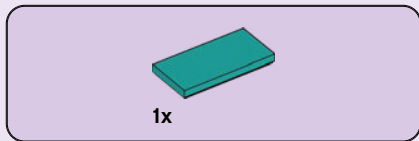

33

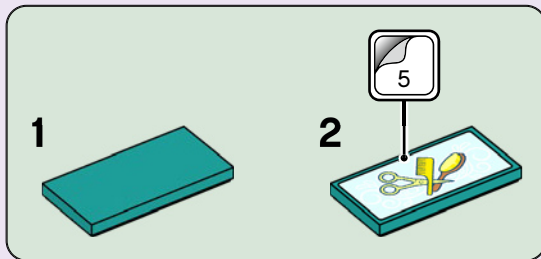



2x

34





2x



2x



2x

# 35

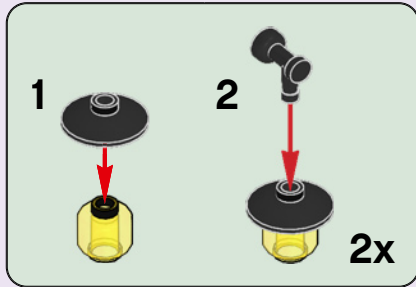

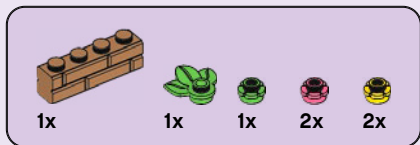

36

1

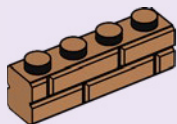

2

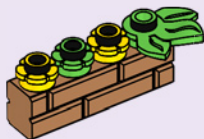

3





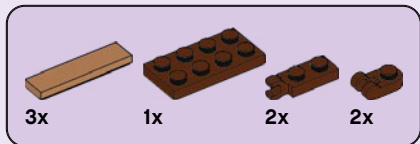

37

1



2

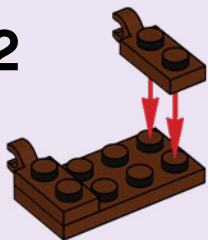

3

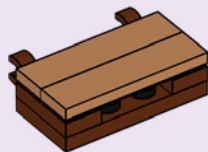

4

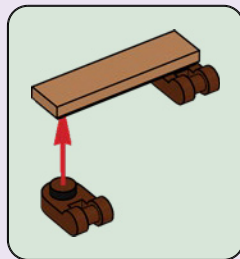
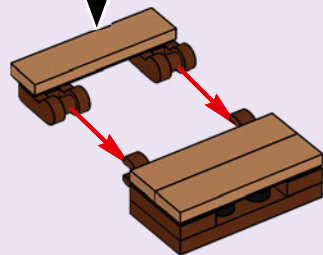



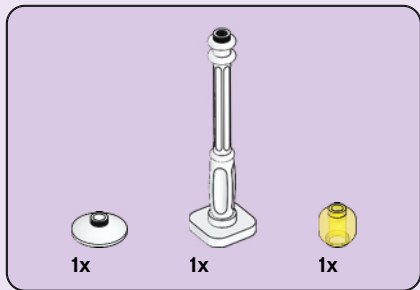

38

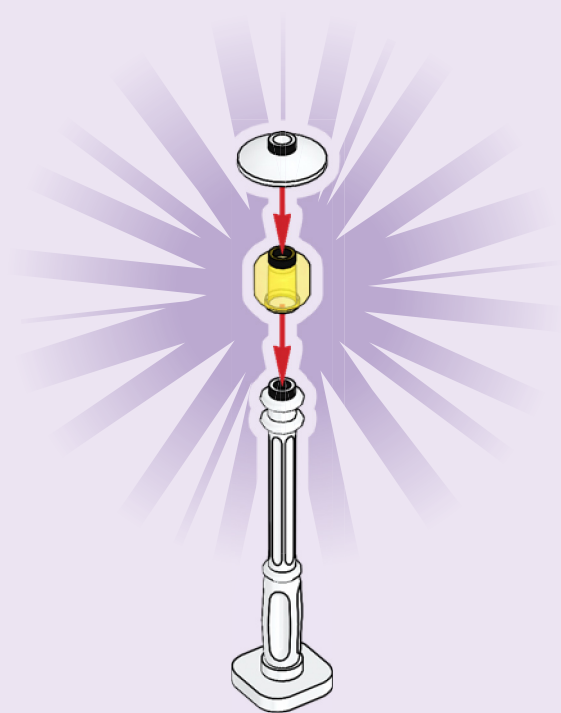







2x

39





# Friends™





# WIN

GO TO [WWW.LEGO.COM/PRODUCTFEEDBACK](http://WWW.LEGO.COM/PRODUCTFEEDBACK) AND  
GIVE US YOUR SHORT **FEEDBACK** ABOUT THIS  
LEGO® SET FOR A CHANCE TO WIN  
A COOL LEGO PRIZE.

Terms & Conditions apply

## LEGO.com/productfeedback

### GEWINNE

Erzähle uns auf  
[www.LEGO.com/productfeedback](http://www.LEGO.com/productfeedback)

etwas über die Erfahrungen, die du mit  
diesem LEGO® Set gemacht hast, und  
sichere dir die Chance auf einen coolen  
LEGO Preis!

Es gelten die Teilnahmebedingungen

### GAGNE

Rends-toi sur  
[www.LEGO.com/productfeedback](http://www.LEGO.com/productfeedback)

et donne-nous quelques commentaires  
sur ce produit LEGO® pour avoir une  
chance de gagner un prix LEGO !

Voir Conditions Générales

### GANAN

Visita  
[www.LEGO.com/productfeedback](http://www.LEGO.com/productfeedback)

y envíanos tu opinión acerca de este  
set LEGO®. ¡Participarás en el sorteo de  
un premio LEGO!

Términos y Condiciones aplicables

### 获取奖品

登录  
[www.LEGO.com/productfeedback](http://www.LEGO.com/productfeedback)

给出关于此乐高®套装的简短反馈，  
就有机会获得炫酷乐高奖品

《条款及条件》适用

LEGO, the LEGO logo and the FRIENDS logo are trademarks of the/son des marques de commerce du/son marcas registradas de LEGO Group.  
©2022 The LEGO Group.

6400016